



CHILD SAFETY





AT DECORA WE PLACE PARAMOUNT IMPORTANCE ON CHILD SAFETY IN OUR HOMES, AIMING TO ENSURE THE POTENTIAL HAZARDS POSED BY UNRESTRAINED CORDS AND CHAINS ARE UNDERSTOOD AND ELIMINATED.

Integral to what we do our child safety campaign is driven by innovation, development and testing.

In line with legislation EN13120, we have carefully considered each blind on an individual basis ensuring that child safety is an essential feature.

With Decora you can be confident that the product choices you make are child safety focused.



Child Safety Per Product	2
Fitting Heights	8
Ultimate Child Safety	12
Motorisation	14
Warning Information	16
Safety in the Home	17
Child Safety Overview	18

For manufacture to full compliancy, a breakaway cord condenser is required. Accumulating the two, three or four cords on the lift side (amount of cords dependent on blind width) Cords are individually knotted with an independent cord fed through the base of the condenser this is then used for lift operation.

Eliminating multiple cords ensures that cord entanglement that may form a hazardous loop, does not occur.

One two piece cleat is also required- LC159. This should be installed as close to the headrail as possible and in all cases, not less than 1.5m from the floor. The cord should be wrapped around the cleat in a figure of 8 motion.

Timberlux tassels have also been tested to evaluation EN16434:2012 reference anti-tangle testing.

Two-piece cleat (supplied for both raise and tilt side) Cord condenser

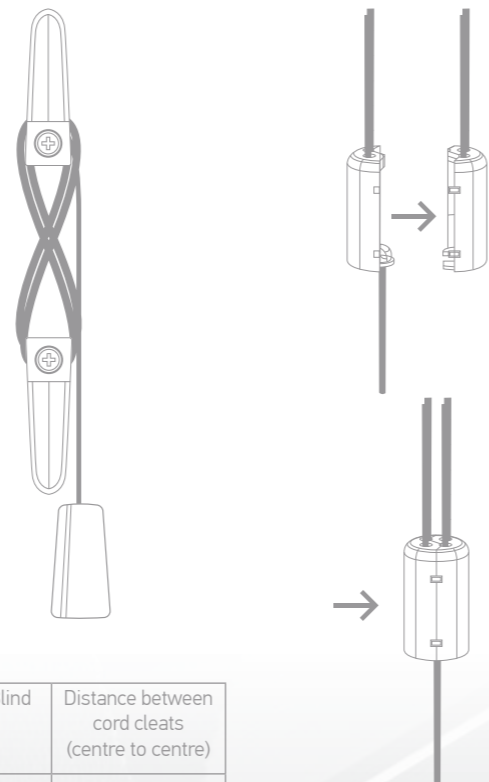

Drop of Blind	Distance between cord cleats (centre to centre)
1-1000mm	100mm
1001-2000mm	150mm
2001-3000mm	300mm

For manufacture to full compliancy, a breakaway cord condenser is required. Accumulating the two, three or four cords on the lift side (amount of cords dependent on blind width) Cords are individually knotted with an independent cord fed through the base of the condenser this is then used for lift operation.

Eliminating multiple cords ensures that cord entanglement that may form a hazardous loop, does not occur.

One two piece cleat is also required-LC159. This should be installed as close to the head-rail as possible and in all cases, not less than 1.5m from the floor. The cord should be wrapped around the cleat in a figure of 8 motion.

Sunwood tassels have also been tested to evaluation EN16434:2012 reference anti-tangle testing.

Two-piece cleat Cord condenser

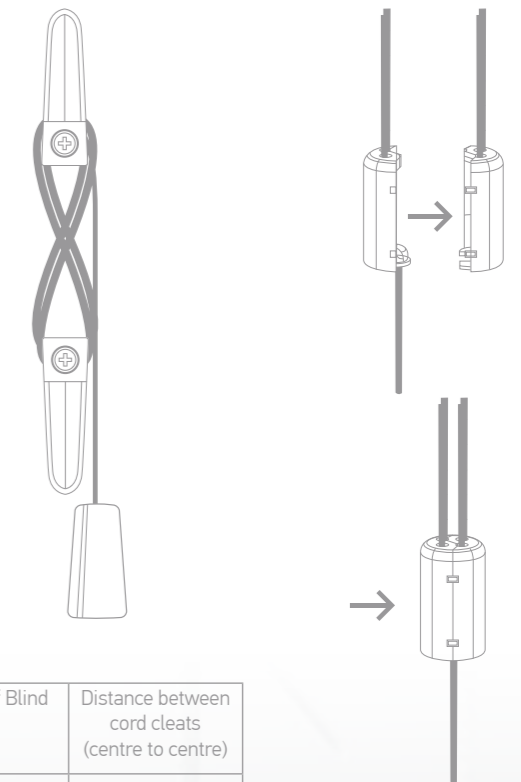

Drop of Blind	Distance between cord cleats (centre to centre)
1-1000mm	100mm
1001-2000mm	150mm
2001-3000mm	300mm

For manufacture to full compliancy, a breakaway cord condenser is required. Accumulating the two, three or four cords on the lift side (amount of cords dependent on blind width) Cords are individually knotted with an independent cord fed through the base of the condenser this then used for lift operation.

Eliminating multiple cords ensures that cord entanglement that may form a hazardous loop, does not occur.

One two piece cleat is also required-LC159. This should be installed as close to the head-rail as possible and in all cases, not less than 1.5m from the floor. The cord should be wrapped around the cleat in a figure of 8 motion.

Excel tassels have also been tested to evaluation EN16434:2012 reference anti-tangle testing.

Two-piece cleat



Cord condenser



Drop of Blind	Distance between cord cleats (centre to centre)
1-1000mm	100mm
1001-2000mm	150mm
2001-3000mm	300mm

Alumitex and Sunvent venetians include a safety breakaway tassel-LC158, all cords are individually knotted within the device ensuring if a downward force interrupts the cords entering the tassel the device breaks away with ease. Two cord stop rings-VC902 are also required in conjunction with a safety tassel and a two piece cleat. The two piece cleat should be installed as close to the head-rail as possible and in all cases, not less than 1.5m from the floor. The cord should be wrapped around the cleat in a figure of 8 motion.



Two-piece cleat



Breakaway Tassel

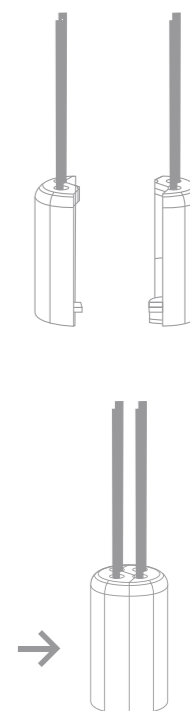

Drop of Blind	Distance between cord cleats (centre to centre)
1-1000mm	100mm
1001-2000mm	150mm
2001-3000mm	300mm



ROLLERS/CHAIN CASSETTES

Three options are available on roller/chain operated cassettes to ensure you meet full compliancy.

Two easy break chain connector positioned a minimum of 200mm apart can be used (RC086/RC092).

Or the choice of two tensioning devices, a cord and chain tidy (LC295/LC296) or tie down clip (LC157)

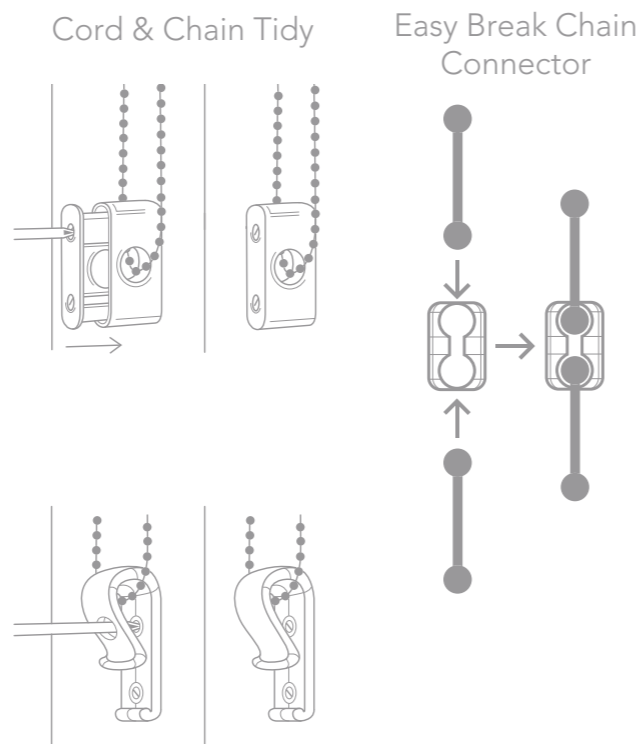

VERTICALS

The choice of two tensioning devices are available for verticals, a cord and chain tidy (LC295/LC296) or tie down clip (LC157).

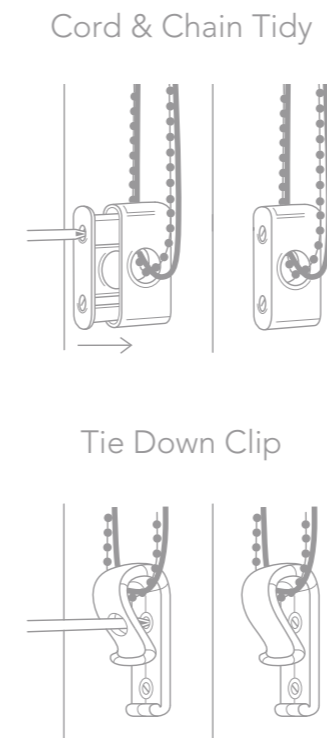

ROMANS

Excel Romans are fitted as standard with a cord condenser and cleat on cord operated romans with a tie-down clip, standard on chain control.

All romans are fitted with a breakaway device on the back lift panels, ensuring all features involving cord/chain are fully compliant and child safe.

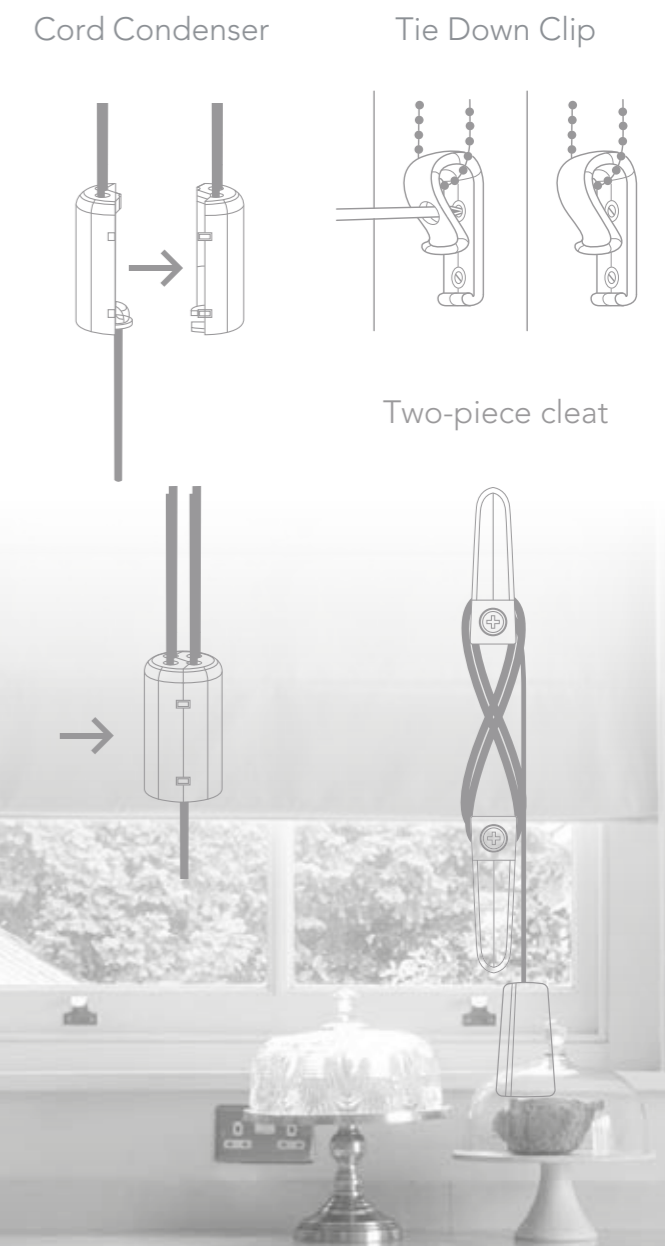



CORD AND CHAIN LENGTHS

OPERATING LOOP - FIXED TENSIONING SYSTEM

(Cord and Chain Tidy/Tie-down Clip)

(Roller, Cassettes & Vertical - easy break chain connector to be used in conjunction with tensioning device for cord on verticals)

If the installation height is **known** the distance from the floor to bottom of pull cords shall be at least 1.5m.

If the installation height is **not known but the drop of the blind is less than 2.5m**, length of the pull cords shall be less than 1m.

If the installation height is **not known but the drop of the blind is more than 2.5m**, length of pull cords shall be less than drop of the blind – 1.5m.

Known Installation Height

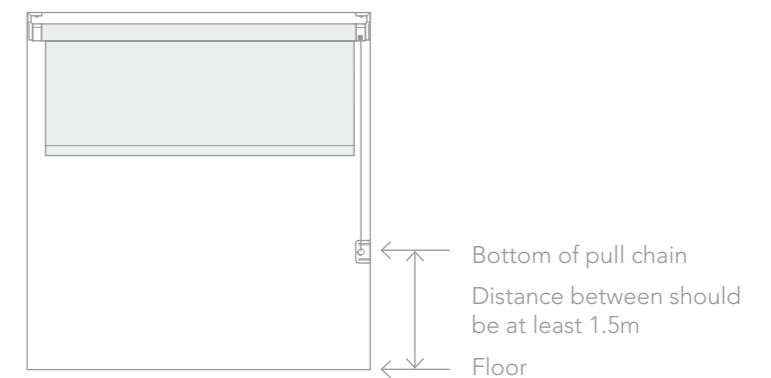

Unknown Installation Height

(If the blind less than 2.5m)

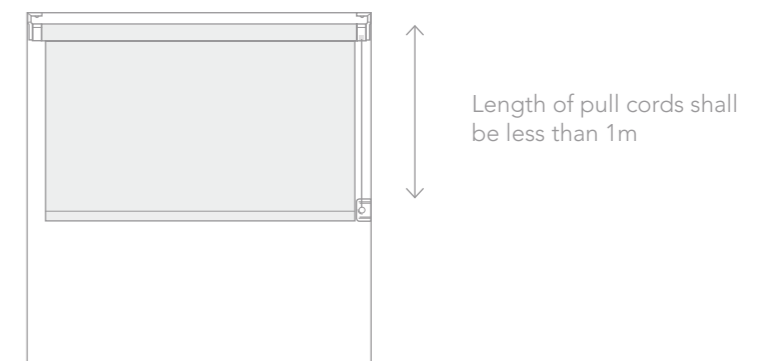

Unknown Installation Height

(If the blind is more than 2.5m)

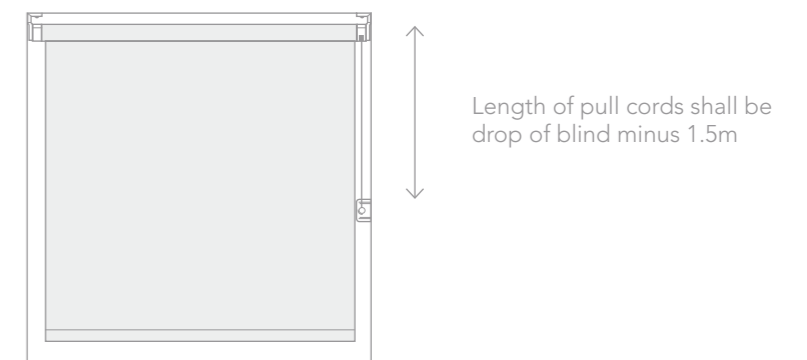

CORD AND CHAIN LENGTHS

OPERATING LOOP - BREAKAWAY SYSTEM

(Easy Break Chain Connector)

(Roller, Vertical & Cassettes)

If the installation height is **known** the cord length distance from the floor to the bottom of the pull cord shall be at least 0.6m.

If the installation height is **not known** the cord length should be less than or equal to 2/3 drop of blind.

Known Installation Height

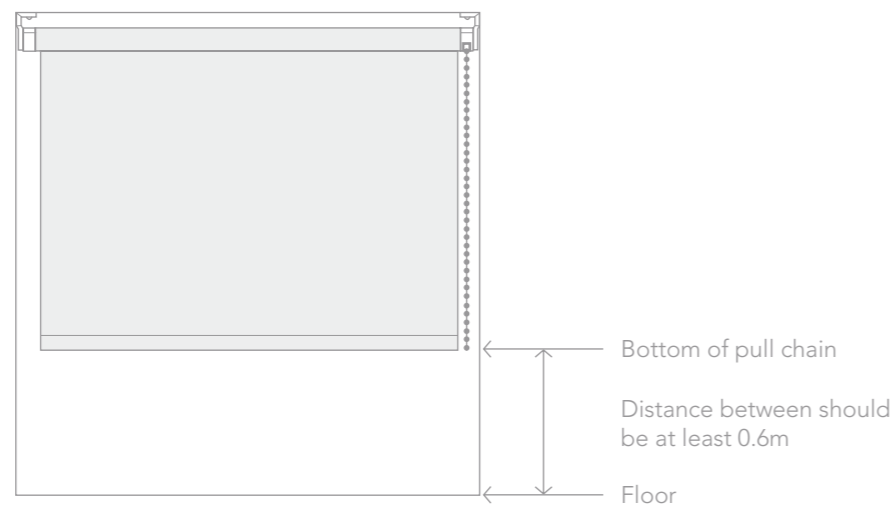

Unknown Installation Height

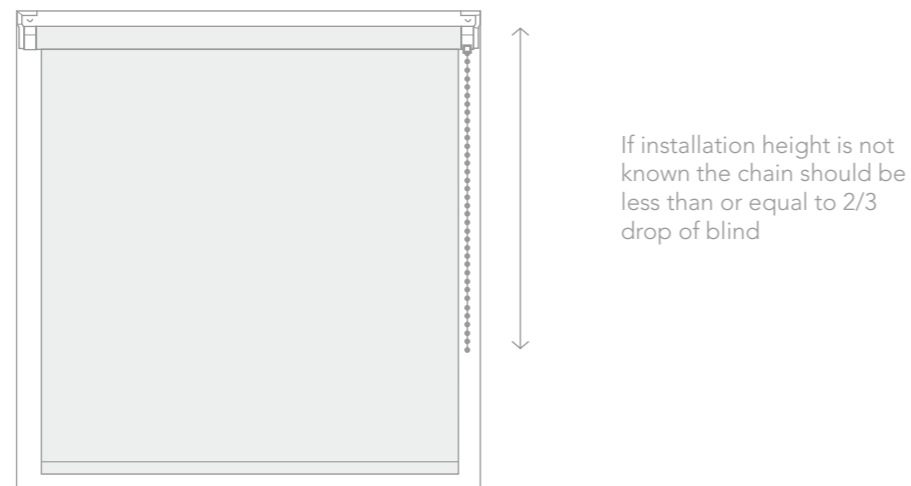

CORD AND CHAIN LENGTHS

PULL CORDS

(Sunwood, Timberlux, Excel Wood, 25mm, 35mm & 50mm Alumitex)

Its recommended the 2 piece cleat is fitted as close to the headrail as possible or alternatively:

If the installation height is **known** the distance from the floor to bottom of pull cords shall be at least 1.5m.

If the installation height is **not known but the drop of the blind is less than 2.5m**, length of the pull cords shall be less than 1m.

If the installation height in **not known but the drop of the blind is more than 2.5m**, length of pull cords shall be less than drop of the blind – 1.5m.

Known Installation Height

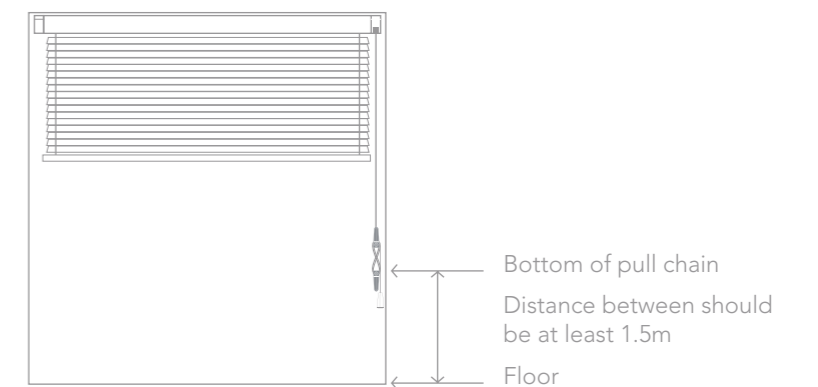

Unknown Installation Height (If the blind less than 2.5m)

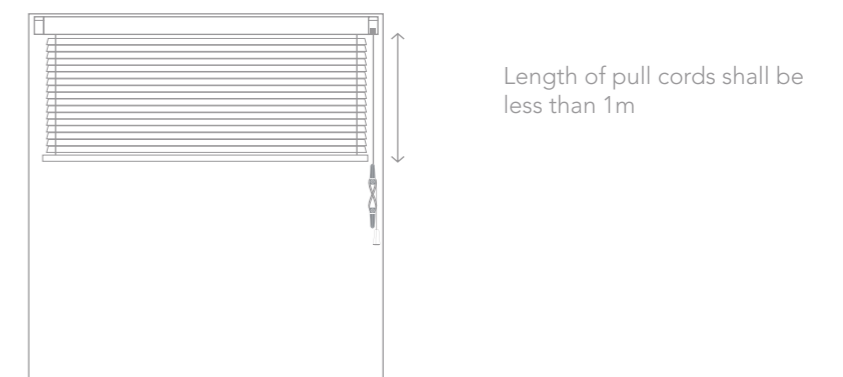

Unknown Installation Height (If the blind is more than 2.5m)

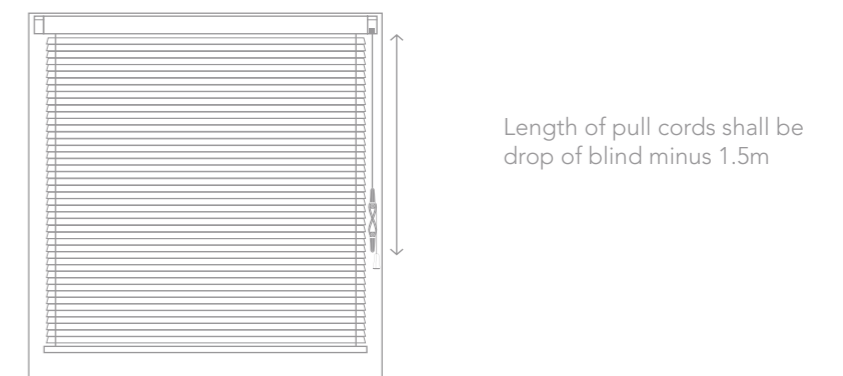

& SAFE & SOUND



ULTIMATE CHILD SAFETY

To ensure total peace of mind, Decora offer a range of child safe products that have no dangerous cords, chains or loops, one of the easiest ways to ensure your window solution is a child safe choice.



MOTORISATION

PANEL BLINDS

CHAINLESS
VERTICAL
SYSTEM

SANTA FE
SHUTTERS

MOVE
ON
UP



MOTORISATION

The absence of cords and chains ensure your blinds are completely child safe, offering complete peace of mind and ultimate convenience.

Motorised blinds provide a wealth of benefits and long term money-saving solutions.

- Child safety - a motorised blind with no operating cord presents a child safe, risk free solution.
- Convenience - ensures you can manage your light control at the touch of a button.
- Hard to reach blinds - easily adjust hard to reach blinds with convenient remote control operation.
- Assisted living - motorised blinds help improve the quality of life for those who may require help with everyday tasks around the home.
- Enhanced protection - light sensors can provide automatic operation to help protect valuable furnishings by providing automatic shading during periods of sunshine.
- Improved security - timers and sensors can provide simulated occupation while the home is unoccupied raising and lowering blinds at set times and conditions.

Decora offer a large range of motor options across our Timberlux, Fabric Box Roller and Alumitex range including a very simple battery operated solution, suitable for smaller blinds (up to 5m²) to more powerful motors powered by DC or AC which are more suitable for larger, heavier blinds.

For further information or advice on motors, lifting capabilities and operating options please contact our Customer Service Department.

In association with

somfy[®]



BE AWARE

Warning information should be detailed clearly on all packaging in several locations to promote awareness. Warning tags in all cases will be fit for the country of use.

- Attached to cords of product - WT001
- Warning information on blind packaging - WT002
- Attached to safety device - WT003
- Warning information on fitting instructions

WARNING

Young children can be strangled by loops in pull cords, chains, tapes and inner cords that operate the product.

To avoid strangulation and entanglement, keep cords out of the reach of young children. Cords may become wrapped around a child's neck.

Move beds, cots and furniture away from window covering cords.

Do not tie cords together. Make sure cords do not twist and create a loop.

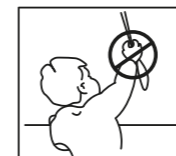

WARNING

Young children can be strangled by loops in pull cords, chains, tapes and inner cords that operate the product.

To avoid strangulation and entanglement, keep cords out of the reach of young children. Cords may become wrapped around a child's neck. Move beds, cots and furniture away from window covering cords.

Do not tie cords together. Make sure cords do not twist and create a loop.

WARNING

Children can strangle if this safety device is not installed. Always use this device to keep cords or chains out of reach of children.





KEEPING SAFE

Decora's philosophy not only promotes child safety across all window coverings but also recommends further steps that can be taken to keep children safe at home.



- Vitrally a child safe device should be fitted in all cases within a child orientated environment, especially bedrooms, ensuring cords and chains do not hang free.
- Furniture should be positioned at a safe enough distance that children cannot climb onto blinds or window ledges.
- Do not place a child's cot, bed, playpen or highchair near a window.
- Do not hang toys or objects that could be a hazard on the cot or bed.
- Do not hang drawstring bags where a small child could get their head through the loop of the drawstring.

CHILD SAFETY THROUGHOUT THE HOME

There are many child proofing gadgets available in the marketplace but the most important safety device is always parental supervision. Many small steps can be taken to ensure hazards throughout the home can be eliminated.

- When cooking ensure saucepan handles are turned away from the edge. A pan handle can be very tempting to a curious child.
- Store any poisonous substances and medication out of reach.
- Be aware of things in the home that could nip little fingers, deck chairs, doors or drawers.
- With an increase in the amount of burns sustained by young children on hair straighteners it's recommended that they are turned off and stored out of reach straight away.
- Children can drown in less than 3cm of water. Never leave children unattended in the bath, paddling pools or in or around water.
- Children can swallow, inhale or choke on items such as small toys, peanuts and marbles. Always choose toys suitable to their age group.
- Fit a safety gate BS EN 1930: 2011 at the top and bottom of stairs. And keep the stairs free from any tripping hazards.

For further information visit www.rosipa.co.uk

DECORA CHILD SAFE PRODUCTS

	Cord & Chain Tidy LC295 (white)	Cord & Chain Tidy LC296 (black)	Tie Down Clip LC157	Easy Break Chain Connector RC086/RC092	Breakaway Cord Condenser	2-Piece Cleat LC159	Breakaway Safety Tassel LC158	Cord Ring Stops VC902	Non Tangle Tassel	Breakaway Device on Back Panel
Spring Operated Roller	Safe By Design									
Excel Mono Verticals (wand operated)	Safe By Design									
Trak One Verticals (wand operated)	Safe By Design									
Panel	Safe By Design									
Santa Fe Shutters	Safe By Design									
System 55 and 90 Cassettes	Safe By Design									
Rollers	•		•	•						
System 40 Chain Operated Cassettes	•	•	•	•						
Verticals	•		•							
Timberlux					•	•		•	•	
Sunwood					•	•		•	•	
Excel Wood					•	•		•	•	
Alumitex					•	•	•	•	•	
Sunvent					•	•	•	•	•	
Excel 25mm Aluminium					•	•		•	•	
Excel Roman			•							•

Mono Control Wand LC300 1.5m LC303 2m LC304	Mono Control Wand Handle LC301	Mono Control Wand Hook LC302	General Warning Tag WT001	Warning Tag on Safety Device WT003	Warning Tag on Packaging WT002	Manufacturer ID on Product Made to Measure	Child Safety Information on Fitting Instructions
n/a	n/a	n/a	n/a	n/a	n/a	n/a	n/a
•	•	•	n/a	n/a	n/a	n/a	n/a
n/a	n/a	n/a	n/a	n/a	n/a	n/a	n/a
n/a	n/a	n/a	n/a	n/a	n/a	n/a	n/a
n/a	n/a	n/a	n/a	n/a	n/a	n/a	n/a
n/a	n/a	n/a	n/a	n/a	n/a	n/a	n/a
			•	•	•	•	•
			•	•	•	•	•
•	•	•	•	•	•	•	•
			•	•	•	•	•
			•	•	•	•	•
			•	•	•	•	•
•	•	•	•	•	•	•	•
			•	•	•	•	•
			•	•	•	•	•

Decora Blind Systems Ltd,
1 Ferguson Drive,
Knockmore Hill Industrial Park,
Lisburn, BT28 2FL
Northern Ireland

E: sales@decora.co.uk
T: +44(0)28 9266 3600
F: +44(0)28 9266 0890
www.decora.co.uk



make it safeTM



INVESTOR IN PEOPLE